

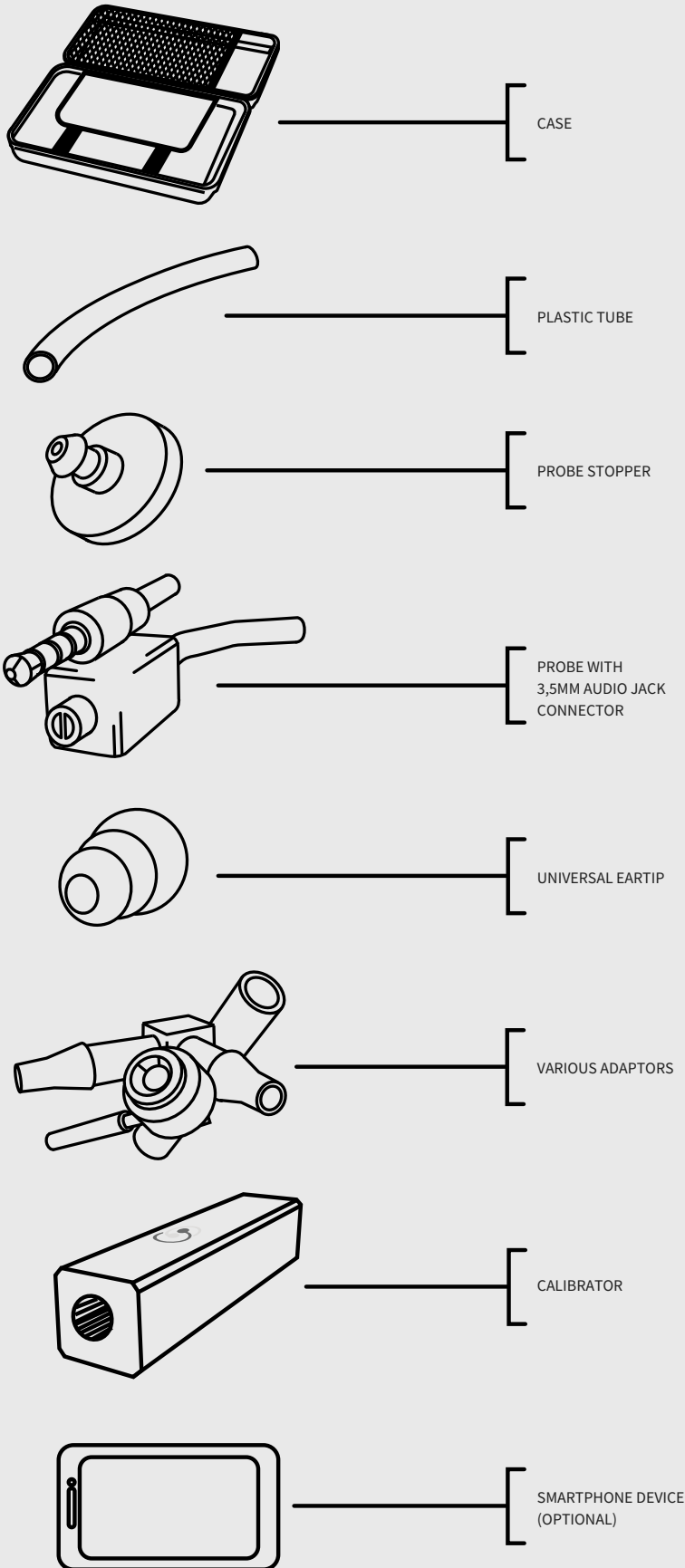

USER MANUAL

WHAT'S IN THE BOX



OPERATING ENVIRONMENT

sealCheck has been designed for use in a professional environment and to assist in validating the fit of custom or reusable earplugs in individuals' ears. This is typically inside a quiet room away from the noise which individuals are exposed to in their working environment.

GENERAL INFORMATION

The sealCheck hardware consists of a probe that attaches to various adaptors that fit onto custom or reusable earplugs. Some adaptors are included. The sealCheck probe has an 3.5 mm audio jack that plugs into a smartphone device. A calibrator unit is provided to calibrate both the output of the device and the microphone inside the probe. The accurate functioning of the seal tests depends on successful calibration. The calibrator has a USB power cable that can be inserted into any USB power supply or computer to power the unit to generate noise for the calibration process.

After calibration, the user attaches the probe (with/without an adaptor) to fit onto a custom or reusable earplug and insert the earplug into the ear canal. The sealCheck probe constantly measures the level of seal, performs calculations and displays the result on a 3-zone meter in the sealCheck app.

Data management of test results is possible and the user is guided in the app to enter relevant information for storing results to the cloud based system.*

sealCheck works on specific Android based smartphones devices.

**Data management, within mHealth Studio, is enabled as a feature of the PRO software subscription.*

INTENDED USE

sealCheck is designed to test for leakages and/or the quality of fit on custom and reusable earplugs. It is an acoustic test that measures the level at which the manufactured custom or reusable earplug forms a seal in the ear canal. These measures can be used to detect nonconformity to manufacturing standards.

sealCheck is intended to be used by manufacturers, representatives, importers and distributors of custom and/or reusable earplugs

LIMITATIONS OF USE

The sealCheck test depends on the accurate and successful completion of the calibration process within a quiet environment. The calibration should not be compromised by any external noise that can be limited for the duration of the calibration process (± 1 minute).

A sealCheck test should always be performed with a sealCheck probe that has been calibrated on the smartphone device being used for testing. When inserting a new probe into the audio jack of the smartphone device always ensure that the calibration process is completed successfully before the probe is used.

IMPORTANT SAFETY WARNINGS

Once removed from its packaging, check that there is no visible damage on the device. In the event of damage do not use it and return it to the seller.

Explanation of markings and symbols relevant to the product:



CE mark : indicates that the device is certified that it conforms to the health, safety and environmental protection standards



Waste electrical and electronic equipment: Dispose accordingly. Do not dispose as unsorted municipal waste.

MAINTENANCE

The sealCheck probe and calibration unit do not require professional maintenance. If, however the outside of the calibrator or probe needs to be cleaned, make sure to only use a damp cloth without any detergent. Make sure that the universal eartip is clean and without any obstructions on the inside.

CALIBRATION

Calibration is required for two reasons:

- Ensure the sealCheck probe accurately measures the noise generated by the calibrator unit. Knowing what level should be measured, (as produced by the calibrator unit) the sealCheck probe is calibrated to measure at the known intensity.
- Using the calibrator noise as a baseline, the noise produced by the smartphone device is then calibrated to ensure the level of noise being produced inside the individual's ear canal is constant

The calibration process works as follows:

Always ensure that calibration is performed in a quiet room. Do not perform calibration if the smartphone device is plugged in or charging.

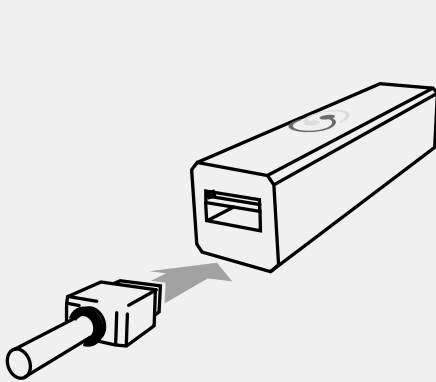

1. Use the supplied USB cable and plug it into the calibrator unit and insert the other end into a power source (i.e. smartphone device charger, computer)

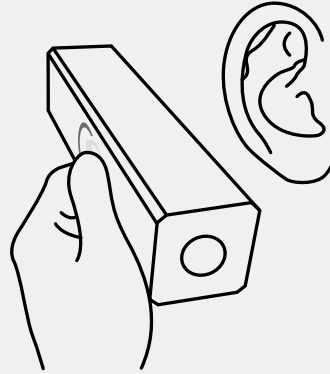

2. Place the calibrator close to your ear to listen if a noise is generated inside the calibrator unit. Confirm this on the sealCheck application. Should no noise be coming from the calibrator unit please revert to the TROUBLESHOOTING section.

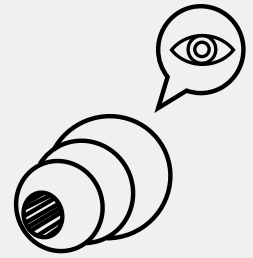

3. Take the provided eartip and ensure there is no obstruction inside before attaching it to the sealCheck probe nozzle.

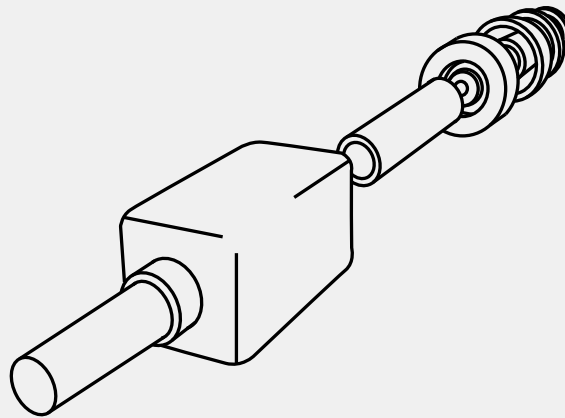

4. Build the probe assembly for calibration check.

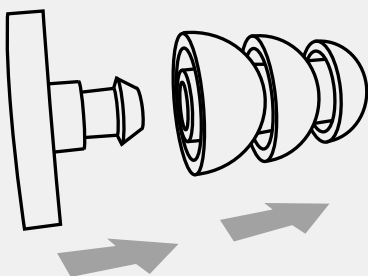

- a. Attach the three-flange eartip to the probe stopper. Ensure the three-flange eartip is attached properly.

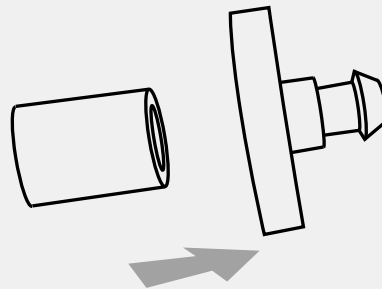

- b. Attach the tip of the plastic tube to the other end of the probe stopper.

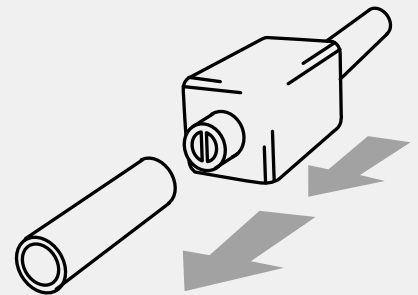

- c. Take the plastic tube and attach it to the sealCheck probe nozzle.

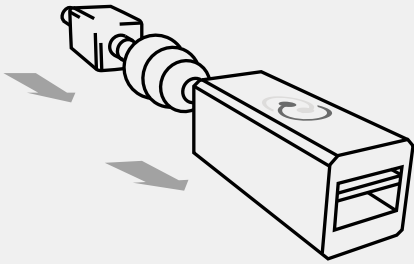

5. Insert the probe assembly into the calibrator unit's opening. Confirm the sealCheck probe has been inserted into the calibrator unit until the probe stopper presses against the calibrator unit. Leave the assembly for a few seconds for the eartip to settle inside the calibrator cavity before starting calibration.

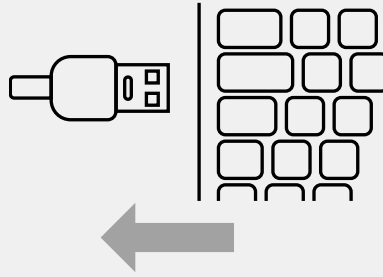

6. Keep the sealCheck probe inserted into the calibrator and unplug the calibrator unit from the power source to stop the noise from being generated inside the calibrator unit.

Wait 3 seconds after disconnecting the USB cable to press proceed button and confirm this step on the smartphone



7. Once calibration is initiated, the sealCheck application will display a countdown. The calibration will automatically commence.

Re-calibration is required monthly and the sealCheck application will automatically prompt the user to start the calibration process once it is due.

USAGE

Probe and adaptors

The sealCheck probe has a dual channel nozzle that fits onto multiple adaptors that then attaches to various types of earplugs.

The sealCheck probe is designed to be worn behind the ear with a plastic tube positioned over the ear (at the top of the helix) to easily reach the earplug positioned in the ear canal (refer to illustration 5). This ensures a comfortable fit and implies that no hand-holding of the probe is required to keep it in place. Furthermore any axial stress that can influence the seal of the earplug is minimised due to the weight of the connector and cable that are supported by the earlobe.

Prepare the sealCheck probe for testing:

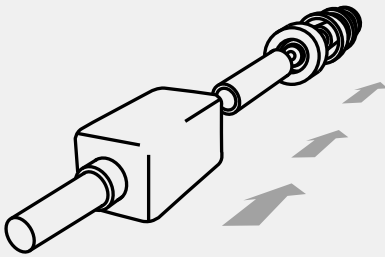

1. Remove the standard three-flange eartip and probe assembly used to complete the calibration process from the sealCheck probe. Do not remove the plastic tube.

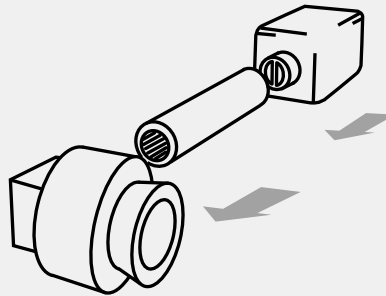

2. Attach the required adaptor that matches the filter of the earplug to be tested at the other end of the plastic tube.

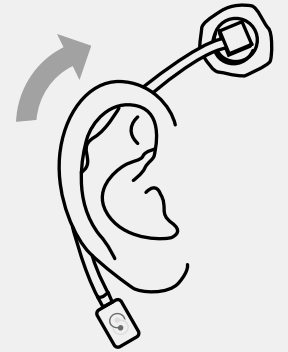

3. After inserting the earplug to be tested in the ear, position the probe with the plastic tube behind the ear. Ensure the plastic tube is pointing upwards to the top part of the helix of the ear.

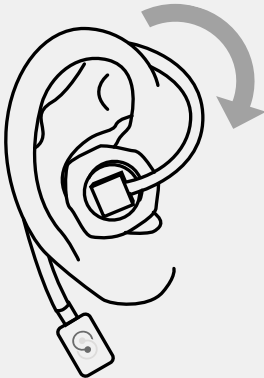

4. Place the plastic tube over the helix towards the ear canal to be attached to the earplug being tested. Attach the adaptor onto the earplug.



5. The earplug is now ready to be tested and the sealCheck application can be started.

DISPLAY

The 3-zone meter indicates the level of the seal of the custom or reusable earplug in the ear canal. Only when a complete seal is formed will the meter display the word 'SEAL' and the needle will be at the maximum point on the gauge.

The 3-zone meter's needle is in the GREEN zone without displaying 'SEAL': This indicates a near-seal. Readjust the custom or reusable earplug in the

individual's ear canal to see if a SEAL can be formed. The sealCheck test is constantly determining if a seal can not be detected and adjusting the fit can result in a seal be formed after a few seconds. If no seal is reached it is possible that alteration work on the earmold is required or a remake might be necessary, depending on how far left the needle points within the green zone.

The 3-zone meter's needle is in the ORANGE or RED zone: No seal can be formed and the earplug should be rejected and manufactured again.

TROUBLESHOOTING

The sealCheck result keeps displaying SEAL even if the probe is disconnected from an earplug inserted into an ear.

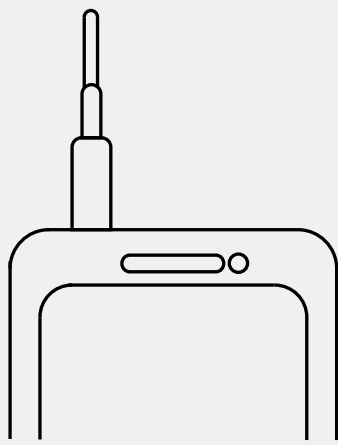

1. Make sure that the audio connector of the sealCheck probe is tightly inserted and makes good contact with the smartphone device.

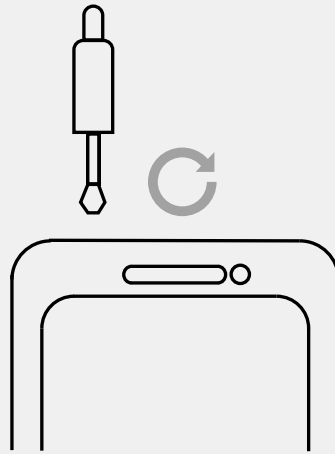

2. Unplug the probe and re-insert if necessary.

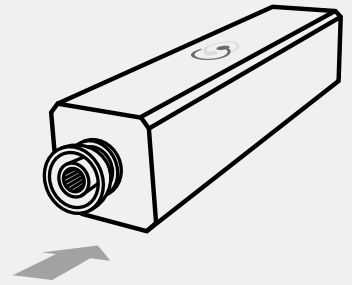

3. Redo the calibration process with the calibrator unit.

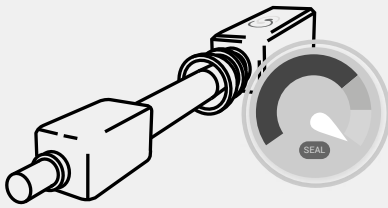

4. Do a test whilst the sealCheck probe is still inserted into the calibrator unit.

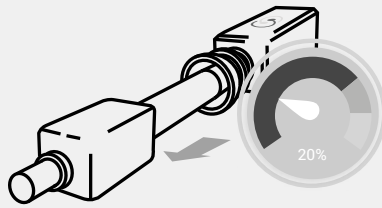

5. When removing the probe from the calibrator make sure that there is a significant drop in the seal indicator.

The calibrator unit does not generate noise.

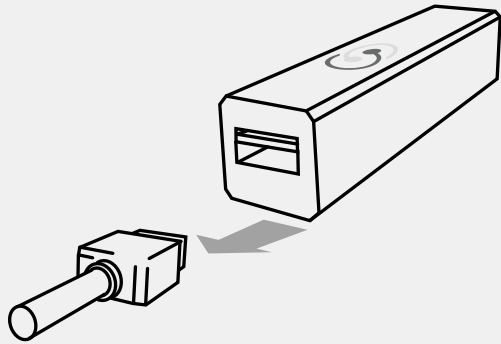

1. Unplug the USB cable from the calibrator unit and remove the USB cable from the power source.

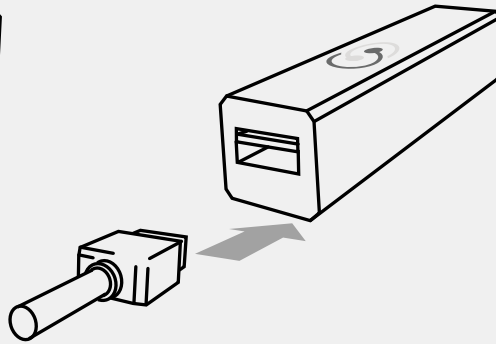

2. Re-insert the USB cable into the calibrator unit and plug it into a power source.

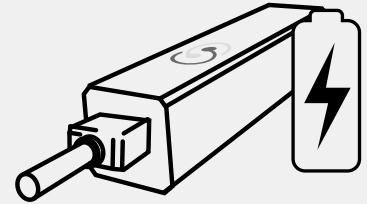

3. Ensure the power source is supplying power to the calibrator unit.

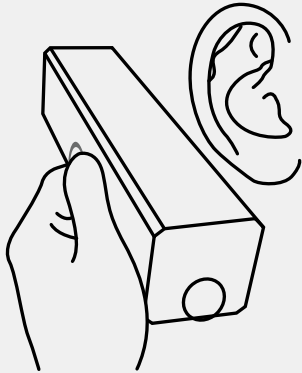

4. Place the calibrator unit close to your ear to listen for noise being generated from the inside of the calibrator unit.



5. Should no noise be played from the calibrator unit, send an email to contact@sealcheck.com for assistance.

The calibration process does not complete successfully.

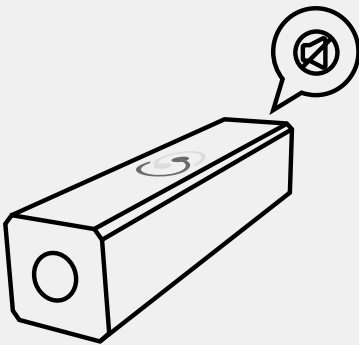

1. The calibrator unit might not be generating noise as part of the calibration process, please revert to the troubleshooting above.

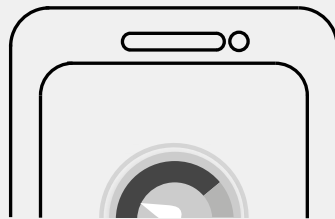

2. Please ensure that no other app is using the device microphone while trying to calibrate.

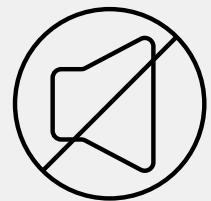

3. Please ensure that no other app is playing audio during the calibration process.



4. Should the above not solve the problem, send an email to contact@sealcheck.com for assistance.

TECHNICAL FEATURES

Measurement method	Acoustic measurement
Power supply and connection	Probe with a 3.5mm a four pole audio jack connector that connects to a smartphone device. Voltage range of between 0.9 - 5V
Dimensions	Probe: 18 x 10 x 8 mm Calibrator: 93 x 22 x 22 mm
Operating conditions	Can be used in locations with an ambient temperature between -10°C and 40°C. Comply with all safety warnings and regulations regarding the usage of mobile devices.
Conditions of storage	Store the device at an ambient temperature between 0°C and 50°C.

NOTEWORTHY

Access to the smartphone device's microphone: The sealCheck app needs to access the smartphone device's microphone to function properly. You can allow access in the smartphone device's settings menu.

Smartphone device's master volume: The volume setting of the smartphone device needs to be set at maximum level to function properly. Increase the volume until the maximum level is reached.